



Thermal Monocular
GRYPHON & GRYPHON LRF Series

User Manual V5.5.76 202312



Contact Us

Table of Contents

Chapter 1 Overview	1
1.1 Device Description	1
1.2 Main Function	1
1.3 Appearance	1
Chapter 2 Preparation	5
2.1 Connect Device	5
2.2 Install Battery	5
2.2.1 Battery Instruction	5
2.2.2 Battery Installation	5
2.3 Power On/Off	7
2.4 Menu Description	8
2.5 App Connection	8
2.6 Firmware Status	9
2.6.1 Check Firmware Status	9
2.6.2 Upgrade Device	10
Chapter 3 Image Settings	11
3.1 Adjust Diopter	11
3.2 Adjust Focus	11
3.3 Adjust Brightness	11
3.4 Adjust Contrast	12
3.5 Adjust Tone	12
3.6 Adjust Sharpness	12
3.7 Select Scene Mode	13
3.8 Set Custom Palettes	13
3.9 Set Fusion Level	16
3.10 Adjust Digital Zoom	16
3.11 Set Picture in Picture Mode	17

Thermal Monocular User Manual

3.12 Correct Defective Pixel	17
3.13 Flat Field Correction.....	18
Chapter 4 Measure Distance	20
4.1 Measure Distance with Laser.....	20
4.2 Measure Distance with Cursor.....	21
Chapter 5 General Settings	22
5.1 Set OSD	22
5.2 Set Brand Logo	22
5.3 Burning Prevention.....	23
5.4 Capture and Video.....	23
5.4.1 Capture Picture.....	23
5.4.2 Record Video.....	23
5.5 Hot Tracking	24
5.6 Export Files	25
5.6.1 Export Files via HIKMICRO Sight.....	25
5.6.2 Export Files via PC.....	26
Chapter 6 System Settings	27
6.1 Adjust Date.....	27
6.2 Synchronize Time.....	27
6.3 Set Language.....	27
6.4 Set Unit.....	28
6.5 CVBS Output	28
6.6 View Device Information.....	28
6.7 Restore Device.....	29
Chapter 7 Frequently Asked Questions.....	30
7.1 Why is the monitor off?.....	30
7.2 The image is not clear, how to adjust it?.....	30
7.3 Capturing or recording fails. What's the problem?.....	30
7.4 Why the PC cannot identify the device?.....	30

Thermal Monocular User Manual

Safety Instruction	31
Legal Information	34
Regulatory Information	36

Chapter 1 Overview

1.1 Device Description

HIKMICRO GRYPHON & GRYPHON LRF thermal monocular supports functions of observation, hotspot, hot tracking, bi-spectrum image fusion, laser distance measurement, and so on. The thermal monocular is mainly applied to scenarios such as hunting, searching and rescuing, hiking, travel, etc.

1.2 Main Function

- Distance Measurement: The device can detect the distance between the target and the device.
- Hot Tracking: The device can detect the highest temperature in the scene and mark the spot.
- App Connection: The device can capture snapshots, record videos, and set parameters by HIKMICRO Sight App after being connected to your phone via hotspot.
- Image Correction: The device supports DPC (Defective Pixel Correction) and FFC (Flat Field Correction) which can optimize the image quality.
- Palettes: The device supports multiple palettes, and you can set the palette mode according to the scene.
- Fusion: The device can display the fusion of thermal view and optical view.

1.3 Appearance

Note

Pictures in this manual are for illustration purpose only. Please take the actual product for reference.

There are two types of thermal monocular. The appearance description of the two types are shown below. Please take the actual product for reference.

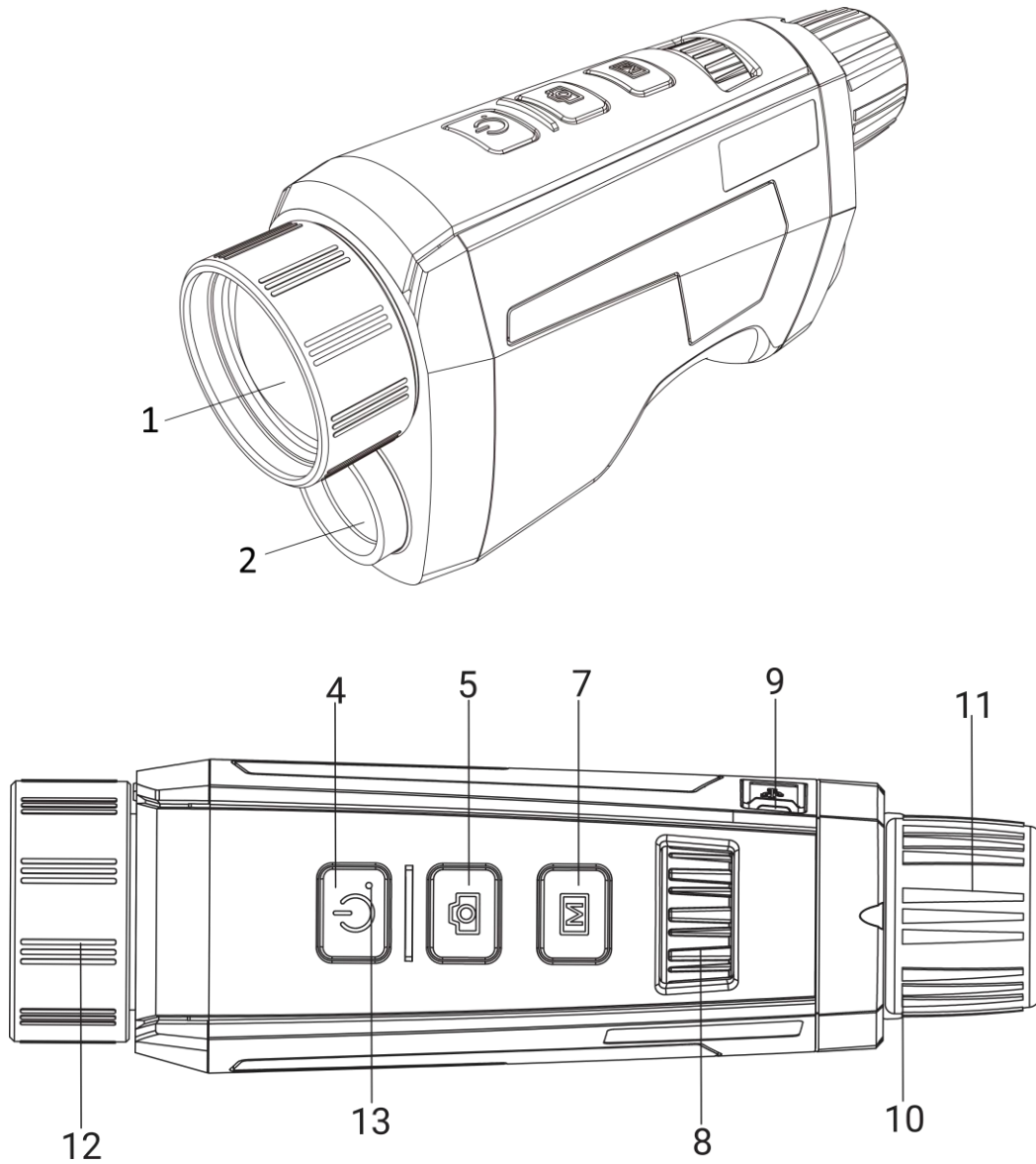

Figure 1-1 Appearance I of Device

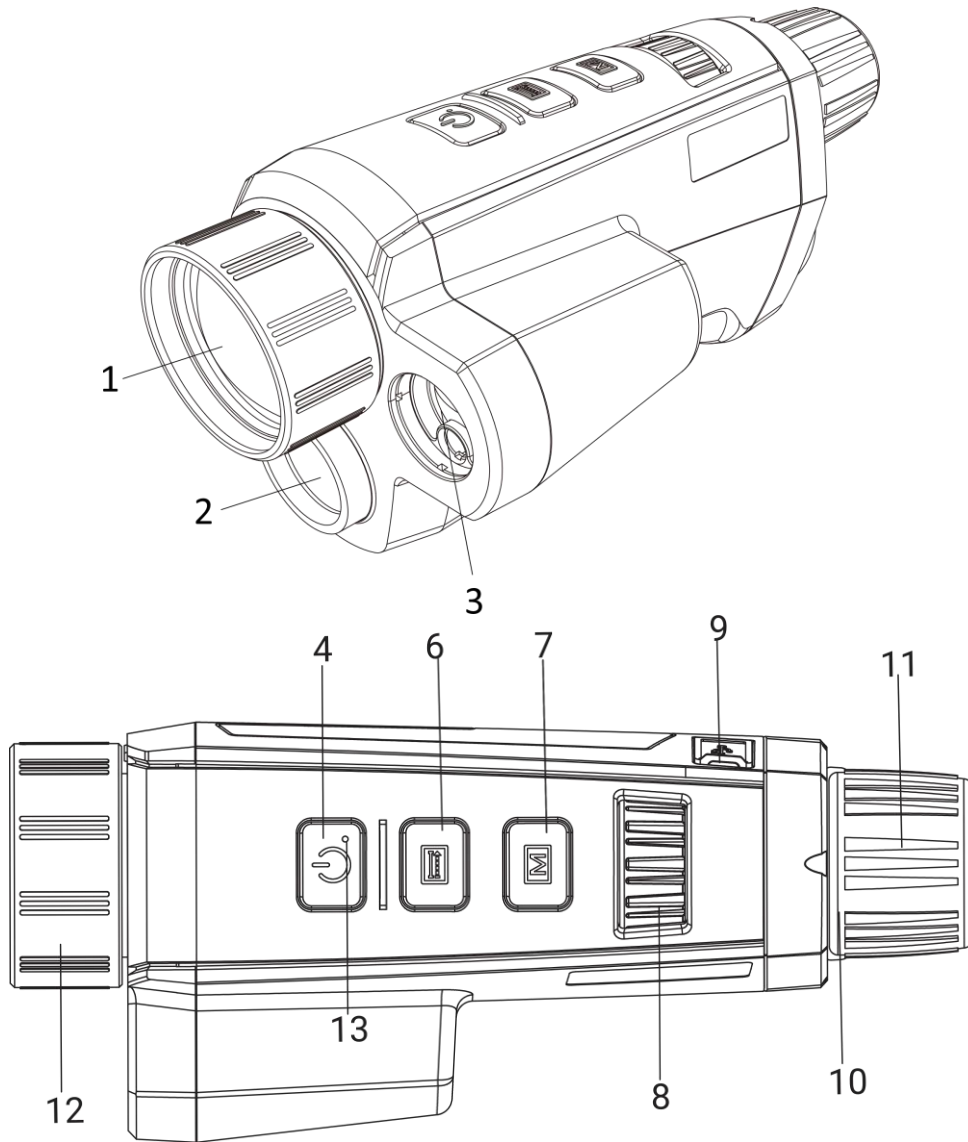

Figure 1-2 Appearance II of Device

Table 1-1 Buttons and Component of Two Appearances

No.	Description	Function
1	Thermal Lens	Views the thermal image.
2	Optical Lens	Views the optical image.
3	Laser Range Finder	Measures the distance with laser.
4	Power Key	<ul style="list-style-type: none"> ● Press: standby mode/wake up device. ● Hold: Power On/Off.
5	Capture Key	<ul style="list-style-type: none"> ● Press: Capture pictures. ● Hold: Correct non-uniformity of display (FFC).

Thermal Monocular User Manual

No.	Description	Function
6	Measure Key	<ul style="list-style-type: none">● Press: Measures the distance with laser.● Double Press: Turn off laser ranging.● Hold: Capture pictures.
7	Menu Key	<ul style="list-style-type: none">● Press: Switch palettes.● Hold: Enter/exit the menu.
8	Wheel	<ul style="list-style-type: none">● Adjusts the digital zoom.● Selects functions in the menu.
9	Type-C Interface	To connect the device to power supply or transmit data with a type-C cable.
10	Eyepiece	The piece placed closest to the eye to view the target.
11	Diopter Adjustment Ring	Adjusts the dioptric setting.
12	Focus Ring	Adjusts focus to obtain clear targets.
13	Indicator	Indicates the on/off mode of the device.

Note

Press the Measure Key/Capture Key and Menu Key at the same time to start or stop recording.

Chapter 2 Preparation

2.1 Connect Device

Before You Start

Turn on the device after connecting it to your PC, and keep the device on for 10 to 15 seconds before other operations.

Steps

1. Lift the cable interface cover.
2. Connect the device and power adapter with a Type-C cable to power on the device. Alternatively, connect the device and PC to export files.

2.2 Install Battery

2.2.1 Battery Instruction

- Remove the battery from the battery compartment if the device is not used for a long time.
- If you are using rechargeable battery, charge it for more than 5 hours before first use.
- The external removable battery type is 18650, and the battery size should be 19.2 mm × 70 mm. The nominal voltage and capacity are 3.6 VDC/3200 mAh.
- The built-in battery type is lithium battery, and the battery size should be 6.8 mm × 2.1 mm. The nominal voltage is 3 VDC, and the rated capacity is 3 mAh.

2.2.2 Battery Installation

Insert the battery into the battery compartment.

Steps

1. Press and push the battery compartment lock (shown in the black frame), rotate the battery cover anticlockwise until the marks on the battery cover and the device are aligned, and disassemble the battery cover.

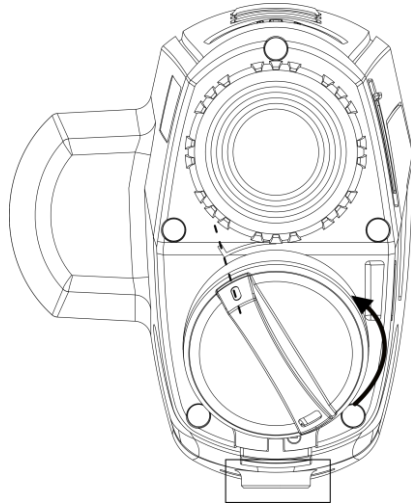

Figure 2-1 Disassemble the Battery Cover

2. Insert the battery into the battery compartment with the positive mark inward.

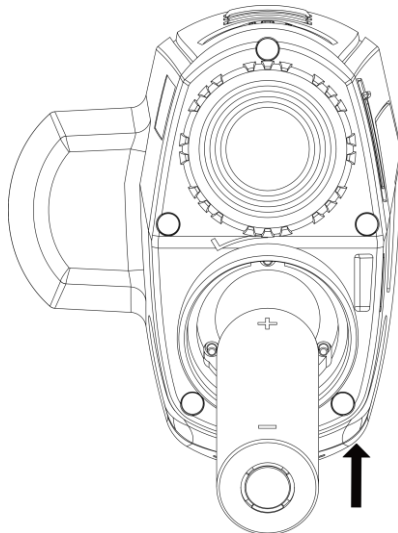

Figure 2-2 Install the Battery

3. Align the marks on the battery cover and the device, and put the battery cover on the battery.

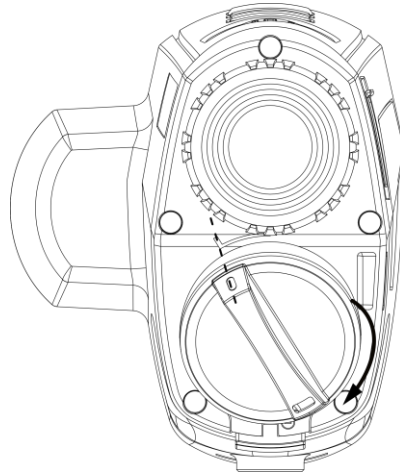



Figure 2-3 Install the Battery Cover

4. Rotate the battery cover clockwise to fix it.

2.3 Power On/Off

Power On

When the battery is enough, hold  to power on the device.

Power Off

When the device is turned on, hold  to power off the device.





Note

- Power-off countdown will appear when you power off the device. You can press any key to interrupt the countdown and cancel the power-off.
 - Automatic low battery power-off cannot be canceled.
-

Auto Power Off

You can set the auto power off time for your device.

Steps

1. In the menu, rotate the wheel to select  **General Settings**, and press  to enter the sub-menu.
 2. Rotate the wheel to select , and press  to confirm.
 3. Rotate the wheel to select the auto power off time as required.
 4. Hold  to save and exit.
-

Note

- See the battery icon for the battery status.  means the battery is fully charged, and
-

 means that the battery is low.

- When the low power note shows, charge the battery.
 - The auto power off takes effect only when the device enters the standby mode and the device isn't connected with HIKMICRO Sight app at the same time.
 - The auto power off countdown will start again when the device reenters standby mode, or the device is restarted.
-

2.4 Menu Description

When the device is turned on, hold  to show the menu.

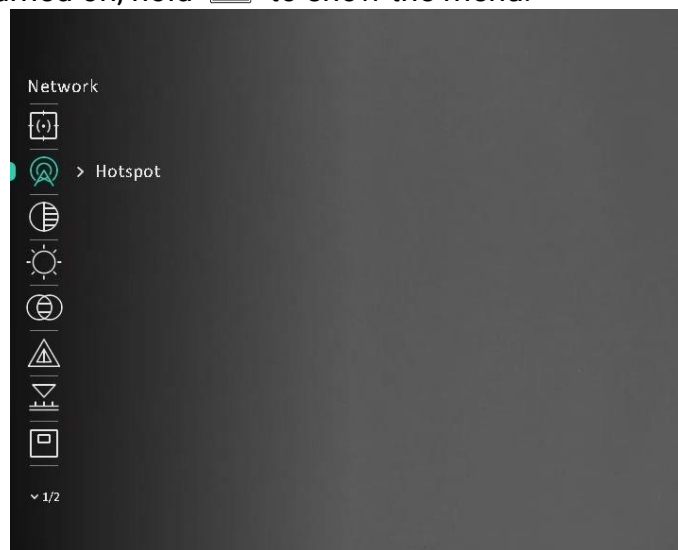

Figure 2-4 Menu Interface

Note

The menu may vary according to different camera models. Take actual products for reference.

2.5 App Connection

Connect the device to the HIKMICRO Sight app via hotspot, then you can capture picture, record video, or configure parameters on your phone.

Steps



1. Search the HIKMICRO Sight on App Store (iOS System) or Google Play™ (Android System) to download it, or scan the QR code to download and install the app.
-



Android System



iOS System

2. In the menu, rotate the wheel to select , and press  to confirm.
3. Rotate the wheel to select **Hotspot**.
4. Turn on the WLAN of your phone and connect to the hotspot.
 - Hotspot Name: HIK-IPTS Serial No.
 - Hotspot Password: Serial No.
5. Open the App and connect your phone with the device. You can view the interface of device on your phone.

Note

- The device cannot connect to the App if entering wrong password several times. Refer to **Restore Device** to reset the device, and connect the App again.
 - The device should be activated for the first use. The default password must be changed after the activation.
-

2.6 Firmware Status

2.6.1 Check Firmware Status

Steps

1. Open HIKMICRO Sight and connect your device to the app.
2. Check if there is an upgrade prompt on the device management interface. If there is no upgrade prompt, the firmware is the latest version. Otherwise, the firmware is not the latest version.

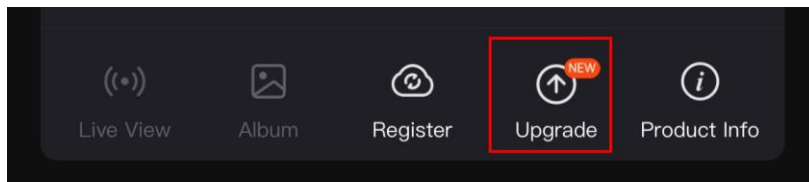

Figure 2-5 Check Firmware Status

3. (Optional) If the firmware is not the latest version, upgrade the device. See *Upgrade Device*.

2.6.2 Upgrade Device

Upgrade Device via HIKMICRO Sight

Before You Start

Install HIKMICRO Sight on your phone and connect your device to the app.

Steps

1. Tap the upgrade prompt to enter the firmware upgrade interface.
2. Tap **Upgrade** to start upgrade.

Note

The upgrading operation may vary due to app updates. Please take the actual app version for reference.

Upgrade Device via PC

Before You Start

- Please get the upgrade package first.
- Turn on the device after connecting it to your PC, and keep the device on for 10 to 15 seconds before other operations.

Steps

1. Connect the device to your PC with cable, and then turn on the device.
2. Open the detected disk, copy the upgrade file and paste it to the root directory of the device.
3. Hold  to reboot the device, and the device upgrades automatically. The upgrading process will be displayed in the main interface.

Note

During the upgrade package transmission, make sure the device is connected to your PC. Otherwise, it may cause unnecessary upgrade failure, firmware damage, etc.

Chapter 3 Image Settings

3.1 Adjust Diopter

Steps

1. Power on the device.
2. Open the lens cover.
3. Hold the device and make sure the eyepiece covers your eye.
4. Adjust the diopter adjustment ring until the OSD text or image is clear.

Note

When adjusting diopter, DO NOT touch the surface of lens to avoid smearing the lens.

3.2 Adjust Focus

Steps



1. Power on the device.
2. Hold the device and make sure the eyepiece covers your eye.
3. Adjust the focus ring until the image is clear.

Note

When focusing, do not touch the surface of lens to avoid smearing the lens.



3.3 Adjust Brightness

Steps

1. In the menu, rotate the wheel to select  and press  to confirm.
2. Rotate the wheel to adjust brightness.
3. Hold  to save and exit.



3.4 Adjust Contrast

Steps

1. In the menu, rotate the wheel to select  and press  to confirm.
2. Rotate the wheel to adjust image contrast.
3. Hold  to save and exit.

3.5 Adjust Tone

Steps

1. In the menu, rotate the wheel to select  and press  to confirm.
2. Rotate the wheel to select a tone. **Warm** and **Cold** can be selected.
3. Hold  to save and exit.





Warm



Cold

3.6 Adjust Sharpness

Steps

1. In the menu, rotate the wheel to select  and press  to confirm.
2. Rotate the wheel to adjust sharpness.
3. Hold  to save and exit.



Sharpness 1





Sharpness 5

3.7 Select Scene Mode

You can select proper scene mode according to actual using scene to improve the display effect.



Steps

1. In the menu, rotate the wheel to select  , and press  to confirm.
2. Rotate the wheel to switch scene.
 - **Recognition**: Recognition mode is recommended in normal scene.
 - **Jungle**: Jungle mode is recommended in hunting environment.
3. Hold  to save settings and exit.

3.8 Set Custom Palettes



You can select different palettes to display the same scene in different effects.

Steps

1. In the menu, rotate the wheel to select  , and press  to go to the palettes interface.
2. Rotate the wheel to select the palettes as required, and press  to enable it/them.

Note

At least one palette should be enabled.

3. Hold  to save the settings and exit.
4. Press  in live view interface to switch the selected palettes.

Optical

The image of optical channel is displayed in this mode.



White Hot

The hot part is light-colored in view. The higher the temperature is, the lighter the color is.



Black Hot

The hot part is black-colored in view. The higher the temperature is, the more black the color is.



Red Hot

The hot part is red-colored in view. The higher the temperature is, the redder the color is.



Fusion

From high temperature to low temperature, the image is colored in from white, yellow, red, pink to purple.



Image Fusion

Fuse the optical image with the thermal image. The fused image with clear edge is



displayed in this mode.



3.9 Set Fusion Level

When the palette is set as image fusion, you can adjust the fusion level according to the actual observation distance to obtain better image fusion effect.



Steps

1. In the menu, rotate the wheel to select , and press  to confirm.
2. Rotate the wheel to select a distance.
3. Hold  to save the settings and exit.

3.10 Adjust Digital Zoom

In the live view interface, rotate the wheel to adjust digital zoom of the device.

Steps

1. In the menu, rotate the wheel to select , and press  to confirm.
2. Rotate the wheel to select a zoom mode.
 - **Multiple:** The digital zoom ratio can be set to 1×, 2×, 4×, and 8×.
 - **Continuous:** The digital zoom ratio can be set from 1.0× to 8.0× continuously.
3. Hold  to save and exit.
4. In the live view interface, rotate the wheel to switch the digital zoom of the device.

Note

When switching the digital zoom ratio, the top-left corner of interface displays the actual magnification (Actual Magnification = Lens Optical Magnification × Digital Zoom Ratio). For example, the lens optical magnification is 2.8× and the digital zoom ratio is 2×, and the actual magnification is 5.6×.

3.11 Set Picture in Picture Mode

Steps



1. In the menu, rotate the wheel to select .
2. Press  to enable PIP mode. The details show in the upper center of the view.
3. Hold  to save the settings and exit.



Figure 3-1 Set Picture in Picture Mode







Note

If digital zoom is enabled, only the PIP view zooms.

3.12 Correct Defective Pixel

The device can correct the defective pixels on the screen which are not performed as expected.

Steps

1. In menu, rotate the wheel to select  **Function Settings**, and press  to enter the sub-menu.
2. Rotate the wheel to select , and press  to enter the DPC setting interface.
3. Press  to select **X** or **Y** axis. If you select **X-axis**, the cursor moves left and right; if you select **Y-axis**, the cursor moves up and down.
4. Rotate the wheel to move the cursor until it reaches the defective pixel.
5. Press  twice to correct the dead pixel.

Note

- The selected defective pixel can be magnified and displayed on the right of the interface.











- If the screen OSD blocks the defective pixel, move the cursor to reach the defective pixel, then the device performs mirror display automatically.
-

3.13 Flat Field Correction

This function can correct non-uniformity of display.

Steps

1. In menu, rotate the wheel to select  **Function Settings**, and press  to enter the sub-menu.
 2. Rotate the wheel to select  **Image Calib.**, and press  to confirm.
 3. Rotate the wheel to switch FFC mode.
 - **Manual FFC:** Rotate the wheel to select  **Trigger Calib.**, and press  to trigger calibration.
 - **Auto FFC:** The device performs FFC automatically according to the set schedule when switching on the camera.
 - **External:** Cover the lens cover, rotate the wheel to select  **Trigger Calib.**, and press  to trigger calibration.
 4. Hold  to save the settings and exit.
-

Note

- You will hear a click and the image will freeze for a second when the device performs FFC.
-

Thermal Monocular User Manual

- For models/devices without laser range finder, hold  to trigger manual FFC.
 - You can also perform manual FFC in auto FFC mode.
-

Chapter 4 Measure Distance

Before You Start

When measuring the distance, keep the hand and the position steady. Otherwise, the accuracy may be affected.

4.1 Measure Distance with Laser

The device can detect the distance between the target and the observation position with laser.

Steps





1. In menu, rotate the wheel to select , and press  to confirm.
2. Rotate the wheel to select the laser ranging mode. Once and continuous modes are selectable.
 - **Continuous:** Measure the distance continuously, and the measurement duration can be selected. The measurement result will be refreshed every 1 s.
 - **Once:** Measure the distance once.
3. Hold  to return to the live view interface.
4. Aim the cursor at the target and press the  key to measure the target distance.





Figure 4-1 Laser Ranging Result

Note

- The laser ranging function is only supported by models with laser range finder.
 - When PIP is enabled, PIP view remains in the distance measurement interface.
 - Press  twice in the live view mode to turn off **Laser Ranging**.
-





4.2 Measure Distance with Cursor

Steps

1. In the menu, rotate the wheel to select , and press  to go to the setting interface.
2. Set the parameters for the target.
 - 1) Rotate the wheel to select the target from **Deer, Grey Wolf, Brown Bear, and Custom.**
 - 2) Press  and rotate the wheel to set target height.

Note

The available height ranges from 0.1 m to 9.0 m.

- 3) Press  to confirm.
 - 4) Hold  to save the settings and return to the distance measurement interface.
3. Align the center of top mark with the edge of target top. Press  to confirm. The cursor blinks on the top edge of the target.
 4. Align the center of bottom mark with the edge of target bottom. Press  to confirm.

Result

The right top of the image displays the distance measurement result and the height of the target.

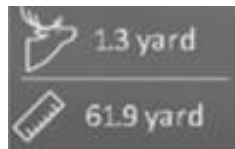



Figure 5-1 Measurement Result

Note







- Go to distance measurement interface, and press  to view the result of the previous measuring target.
 - When PIP is enabled, PIP view remains in the distance measurement interface.
-

Chapter 5 General Settings

5.1 Set OSD

This function can display or hide the OSD information on the live view interface.

Steps

1. In the menu, rotate the wheel to select  **Function Settings**, and press  to enter the sub-menu.
2. Rotate the wheel to select , and press  to enter the OSD setting interface.
3. Rotate the wheel to select the OSD information you want to display or not.
4. Press  to enable the selected OSD information.
5. Hold  to save the settings and exit.





Note

If you turn off **OSD**, all OSD information on the live view will not be displayed.

5.2 Set Brand Logo

You can add brand logo on the live view interface.

Steps

1. In the menu, rotate the wheel to select  **Function Settings**, and press  to enter the sub-menu.
2. Rotate the wheel to select , and press  to enable **Brand Logo**.
3. Hold  to save the settings and exit.

Result

The brand logo is displayed at the bottom right of the image.





Note

After enabling this function, the brand logo only displays on the live view interface, captures and videos.

5.3 Burning Prevention

This function can prevent the detector of the thermal channel from being burned. When enabling this function, the shield will close if the grey scale of the detector reaches a certain value.

Steps



1. In menu, rotate the wheel to select  **Function Settings** and press  to enter the sub-menu.
2. Rotate the wheel to select , and press  to enable the burn-prevention function.
3. Hold  to save the settings and exit.

Note

Avoid direct sunlight and enable the Burning Prevention function to reduce the risk of sensor damage from the heat.

5.4 Capture and Video

5.4.1 Capture Picture

In the main live view interface, hold  or press  to capture pictures. The device supports capturing pictures while recording videos.

Note

When capturing succeeds, the image freezes for 1 second and a prompt shows on the display.

For exporting captured pictures, refer to *Export Files*.

5.4.2 Record Video

Steps







1. In the live view interface, press / and  at the same time to start recording.



Figure 5-1 Start Recording

The left top of image displays the information of recording time.

2. Press /  and  at the same time again to stop recording.

What to do next

For exporting recording files, refer to *Export Files*.

5.5 Hot Tracking

The device can detect the highest temperature spot in the scene and mark it on display.

Steps

1. Hold  to show the menu.

2. Rotate the wheel to select , and press  to mark the spot of highest temperature.

Result



When the function is enabled,  displays in the spot of highest temperature. When the scene changes, the  moves.



Figure 5-2 Hot Tracking

5.6 Export Files

This function is used to export recorded videos and captured pictures.

5.6.1 Export Files via HIKMICRO Sight

You can access device albums and export files to your phone via HIKMICRO Sight.

Before You Start

Install HIKMICRO Sight on your mobile phone.

Steps

1. Open HIKMICRO Sight and connect your device to the app. See *App Connection*.
2. Tap **Media** to access device albums.

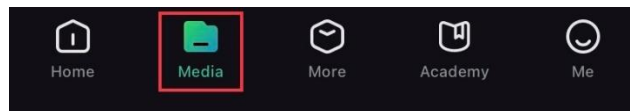

Figure 5-3 Access Device Album

3. Tap **Local** or **Device** to view the photos and videos.
 - **Local**: You can view the previous files on the app.
 - **Device**: You can view the files of the current device.

Note

The photos or videos may not show in **Device**. Please pull down to refresh the page.

4. Tap to select a file, and tap **Download** to export the file to your local phone albums.



Figure 5-4 Download Files

Note

- Go to **Me > About > User Manual** on the app to see more detailed operations.
- You can also access device albums by tapping bottom left icon in the live view interface.

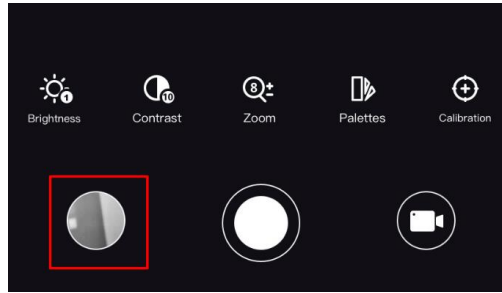

Figure 5-5 Access Device Albums

- The exporting operation may vary due to app updates. Please take the actual app version for reference.
-

5.6.2 Export Files via PC

Steps

1. Connect the device and PC with a Type-C cable.
-

Note

Make sure the device is turned on when connecting the cable.

2. Open computer disk and select the disk of device. Go to the **DCIM** folder and find the folder named after the capture year and month. For example, if you capture a picture or record a video in June 2022, go to **DCIM > 202206** to find the picture or video.
 3. Select and copy the files to PC.
 4. Disconnect the device from your PC.
-





Note

- The device displays images when you connect it to PC, but functions such as recording, capturing and hotspot are disabled.
 - When you connect the device to PC for the first time, it installs the drive program automatically.
-

Chapter 6 System Settings







6.1 Adjust Date

Steps

1. In the menu, rotate the wheel to select  **General Settings**, and press  to enter the sub-menu.
2. Rotate the wheel to select .
3. Press  to select the year, month, or day, and rotate the wheel to change the number.
4. Hold  to save settings and exit.

6.2 Synchronize Time





Steps

1. In the menu, rotate the wheel to select  **General Settings**, and press  to enter the sub-menu.
2. Rotate the wheel to select .
3. Press  and rotate the wheel to switch the clock system. 24-hour and 12-hour clock are selectable. If you select 12-hour clock, press  and rotate the wheel to select AM or PM.
4. Press  to select the hour or minute, and rotate the wheel to change the number.
5. Hold  to save settings and exit.

6.3 Set Language

You can select the device language in this function.

Steps





1. In the menu, rotate the wheel to select  **General Settings**, and press  to enter the sub-menu.
2. Rotate the wheel to select , and press  to enter the language configuration interface.
3. Rotate the wheel to select the language as required, and press  to confirm.

4. Hold  to exit.

6.4 Set Unit

You can switch the unit for fusion level and laser ranging functions.

Steps

1. In the menu, rotate the wheel to select  **General Settings**, and press  to enter the sub-menu.
2. Rotate the wheel to select , and press  to switch the unit. **Yard** and **m** (meter) are selectable.
3. Hold  to save settings and exit.





6.5 CVBS Output

The CVBS output is used to debug the device. You can also view the device image on the display unit for details.

Before You Start

Connect the device to the display unit via CVBS interface of the aviation plug.

Steps

1. In the menu, rotate the wheel to select  **Function Settings**, and press  to enter the sub-menu.
2. Rotate the wheel to select , and press  to switch on CVBS.
3. Hold  to save settings and exit.

Note

The CVBS cable is not included in the package, please purchase it by yourself.

6.6 View Device Information





Steps

1. In the menu, rotate the wheel to select  **General Settings**, and press  to enter the sub-menu.
2. Rotate the wheel to select , and press . You can view the device information

such as version, and serial No.

6.7 Restore Device

Steps

1. In the menu, rotate the wheel to select  **General Settings**, and press  to enter the sub-menu.
2. Rotate the wheel to select  .
3. Press  to restore the device to defaults according to the prompt.

Chapter 7 Frequently Asked Questions

7.1 Why is the monitor off?

Check the following items.

- Check whether the device is off-battery.
- Check the monitor after charging the device for 5 minutes.

7.2 The image is not clear, how to adjust it?

Adjust the diopter adjustment ring or focus ring until the image is clear. Refer to *Adjust Diopter* or *Adjust Focus*.

7.3 Capturing or recording fails. What's the problem?

Check the following items.

- Whether the device is connected to your PC. Capturing or recording is disabled in this status.
- Whether the storage space is full.
- Whether the device is low-battery.

7.4 Why the PC cannot identify the device?

Check the following items.

- Whether the device is connected to your PC with supplied USB cable.
- If you use other USB cables, make sure the cable length is no longer than 1 m.

Safety Instruction



These instructions are intended to ensure that user can use the product correctly to avoid danger or property loss.

Laws and Regulations

- Use of the product must be in strict compliance with the local electrical safety regulations.

Symbol Conventions

The symbols that may be found in this document are defined as follows.

Symbol	Description
 Danger	Indicates a hazardous situation which, if not avoided, will or could result in death or serious injury.
 Caution	Indicates a potentially hazardous situation which, if not avoided, could result in equipment damage, data loss, performance degradation, or unexpected results.
 Note	Provides additional information to emphasize or supplement important points of the main text.

Transportation

- Keep the device in original or similar packaging while transporting it.
- Keep all wrappers after unpacking them for future use. In case of any failure occurred, you need to return the device to the factory with the original wrapper. Transportation without the original wrapper may result in damage on the device and the company shall not take any responsibilities.
- DO NOT drop the product or subject it to physical shock. Keep the device away from magnetic interference.

Power Supply

- Input voltage should meet the Limited Power Source (5 VDC, 2A) according to the IEC61010-1 standard. Please refer to technical specifications for detailed information.
- Make sure the plug is properly connected to the power socket.
- DO NOT connect multiple devices to one power adapter, to avoid over-heating or fire hazards caused by overload.
- The battery charger is included in the package. The input voltage for the supplied battery charger should meet the Limited Power Source (5 VDC, 2 A).

Battery

- Improper use or replacement of the battery may result in explosion hazard. Replace with the same or equivalent type only.
- The external removable battery type is 18650, and the battery size should be 19.2 mm × 70 mm. The nominal voltage and capacity are 3.6 VDC/3200 mAh.
- The built-in battery type is lithium battery, and the battery size should be 6.8 mm × 2.1 mm. The nominal voltage is 3 VDC, and the rated capacity is 3 mAh.
- Dispose of used batteries in conformance with the instructions provided by the battery manufacturer.
- For long-term storage of the battery, make sure it is fully charged every half year to ensure the battery quality. Otherwise, damage may occur.
- Do not charge other battery types with the supplied charger. Confirm there is no flammable material within 2 m of the charger during charging.
- DO NOT place the battery near heating or fire source. Avoid direct sunlight.
- DO NOT swallow the battery to avoid chemical burns.
- DO NOT place the battery in the reach of children.
- The battery cannot be charged with external power source directly.
- The device cannot be charged, please use the supplied charger to charge the battery.
- Please purchase the adapter by yourself. The using environment of the adapter should be consistent with that of the device.
- The built-in battery cannot be dismantled. Please contact the manufacture for repair if necessary.

Maintenance

- If the product does not work properly, please contact your dealer or the nearest service center. We shall not assume any responsibility for problems caused by unauthorized repair or maintenance.
- Wipe the device gently with a clean cloth and a small quantity of ethanol, if necessary.
- If the equipment is used in a manner not specified by the manufacturer, the protection provided by the device may be impaired.
- Clean the lens with soft and dry cloth or wiping paper to avoid scratching it.

Using Environment

- Make sure the running environment meets the requirement of the device. The operating temperature shall be -30 °C to 55 °C (-22 °F to 131 °F), and the operating humidity shall be 95% or less.
- DO NOT expose the device to extremely hot, cold, dusty, corrosive, saline-alkali, or damp environments.
- Avoid equipment installation on vibratory surface or places subject to shock (neglect may cause equipment damage).

- DO NOT aim the lens at the sun or any other bright light.

Emergency

If smoke, odor, or noise arises from the device, immediately turn off the power, unplug the power cable, and contact the service center.

Laser

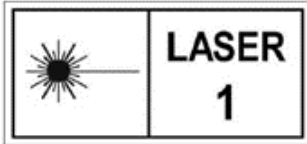

When any laser equipment is in use, make sure that the device lens is not exposed to the laser beam, or it may burn out. The laser radiation emitted from the device can cause eye injuries, burning of skin or inflammable substances. Before enabling the laser ranging function, make sure no human or inflammable substances are in front of the laser lens. Do not place the device where minors can fetch it. The wavelength is 905 nm, and the max. power output is less than 0.252 mW. According to IEC 60825-1:2014 and EN 60825-1:2014+A11:2021, this laser product is classified as Class 1 laser product.

Manufacture Address

Room 313, Unit B, Building 2, 399 Danfeng Road, Xixing Subdistrict, Binjiang District,
Hangzhou, Zhejiang 310052, China
Hangzhou Microimage Software Co., Ltd.

COMPLIANCE NOTICE: The thermal series products might be subject to export controls in various countries or regions, including without limitation, the United States, European Union, United Kingdom and/or other member countries of the Wassenaar Arrangement. Please consult your professional legal or compliance expert or local government authorities for any necessary export license requirements if you intend to transfer, export, re-export the thermal series products among different countries.

Legal Information

©2023 Hangzhou Microimage Software Co., Ltd. All rights reserved.

About this Manual

The Manual includes instructions for using and managing the Product. Pictures, charts, images and all other information hereinafter are for description and explanation only. The information contained in the Manual is subject to change, without notice, due to firmware updates or other reasons. Please find the latest version of this Manual at the HIKMICRO website (<http://www.hikmicrotech.com>).

Please use this Manual with the guidance and assistance of professionals trained in supporting the Product.

Trademarks



HIKMICRO and other HIKMICRO's trademarks and logos are the properties of HIKMICRO in various jurisdictions.

Other trademarks and logos mentioned are the properties of their respective owners.

Disclaimer

TO THE MAXIMUM EXTENT PERMITTED BY APPLICABLE LAW, THIS MANUAL AND THE PRODUCT DESCRIBED, WITH ITS HARDWARE, SOFTWARE AND FIRMWARE, ARE PROVIDED "AS IS" AND "WITH ALL FAULTS AND ERRORS". HIKMICRO MAKES NO WARRANTIES, EXPRESS OR IMPLIED, INCLUDING WITHOUT LIMITATION, MERCHANTABILITY, SATISFACTORY QUALITY, OR FITNESS FOR A PARTICULAR PURPOSE. THE USE OF THE PRODUCT BY YOU IS AT YOUR OWN RISK. IN NO EVENT WILL HIKMICRO BE LIABLE TO YOU FOR ANY SPECIAL, CONSEQUENTIAL, INCIDENTAL, OR INDIRECT DAMAGES, INCLUDING, AMONG OTHERS, DAMAGES FOR LOSS OF BUSINESS PROFITS, BUSINESS INTERRUPTION, OR LOSS OF DATA, CORRUPTION OF SYSTEMS, OR LOSS OF DOCUMENTATION, WHETHER BASED ON BREACH OF CONTRACT, TORT (INCLUDING NEGLIGENCE), PRODUCT LIABILITY, OR OTHERWISE, IN CONNECTION WITH THE USE OF THE PRODUCT, EVEN IF HIKMICRO HAS BEEN ADVISED OF THE POSSIBILITY OF SUCH DAMAGES OR LOSS.

YOU ACKNOWLEDGE THAT THE NATURE OF THE INTERNET PROVIDES FOR INHERENT SECURITY RISKS, AND HIKMICRO SHALL NOT TAKE ANY RESPONSIBILITIES FOR ABNORMAL OPERATION, PRIVACY LEAKAGE OR OTHER DAMAGES RESULTING FROM CYBER-ATTACK, HACKER ATTACK, VIRUS INFECTION, OR OTHER INTERNET SECURITY RISKS; HOWEVER, HIKMICRO WILL PROVIDE TIMELY TECHNICAL SUPPORT IF REQUIRED. YOU AGREE TO USE THIS PRODUCT IN COMPLIANCE WITH ALL APPLICABLE LAWS, AND YOU ARE SOLELY RESPONSIBLE FOR ENSURING THAT YOUR USE CONFORMS TO THE

Thermal Monocular User Manual

APPLICABLE LAW. ESPECIALLY, YOU ARE RESPONSIBLE, FOR USING THIS PRODUCT IN A MANNER THAT DOES NOT INFRINGE ON THE RIGHTS OF THIRD PARTIES, INCLUDING WITHOUT LIMITATION, RIGHTS OF PUBLICITY, INTELLECTUAL PROPERTY RIGHTS, OR DATA PROTECTION AND OTHER PRIVACY RIGHTS. YOU SHALL NOT USE THIS PRODUCT FOR ILLEGAL HUNTING ANIMALS, INVASION OF PRIVACY OR ANY OTHER PURPOSE WHICH IS ILLEGAL OR DETRIMENTAL TO THE PUBLIC INTEREST. YOU SHALL NOT USE THIS PRODUCT FOR ANY PROHIBITED END-USES, INCLUDING THE DEVELOPMENT OR PRODUCTION OF WEAPONS OF MASS DESTRUCTION, THE DEVELOPMENT OR PRODUCTION OF CHEMICAL OR BIOLOGICAL WEAPONS, ANY ACTIVITIES IN THE CONTEXT RELATED TO ANY NUCLEAR EXPLOSIVE OR UNSAFE NUCLEAR FUEL-CYCLE, OR IN SUPPORT OF HUMAN RIGHTS ABUSES. IN THE EVENT OF ANY CONFLICTS BETWEEN THIS MANUAL AND THE APPLICABLE LAW, THE LATTER PREVAILS.

Regulatory Information

These clauses apply only to the products bearing the corresponding mark or information.

FCC Information

Note: This product has been tested and found to comply with the limits for a Class B digital device, pursuant to Part 15 of the FCC Rules. These limits are designed to provide reasonable protection against harmful interference in a residential installation. This product generates, uses, and can radiate radio frequency energy and, if not installed and used in accordance with the instructions, may cause harmful interference to radio communications. However, there is no guarantee that interference will not occur in a particular installation. If this product does cause harmful interference to radio or television reception, which can be determined by turning the equipment off and on, the user is encouraged to try to correct the interference by one or more of the following measures:

- Reorient or relocate the receiving antenna.
- Increase the separation between the equipment and receiver.
- Connect the equipment into an outlet on a circuit different from that to which the receiver is connected.
- Consult the dealer or an experienced radio/TV technician for help.

Please take attention that changes or modification not expressly approved by the party responsible for compliance could void the user's authority to operate the equipment.

This device complies with Part 15 of the FCC Rules. Operation is subject to the following two conditions:

- (1) This device may not cause harmful interference, and
- (2) This device must accept any interference received, including interference that may cause undesired operation.

This equipment complies with FCC radiation exposure limits set forth for an uncontrolled environment.

Note: Due to the device size limit, the above statement may not be disclaimed on the device.

EU Compliance Statement



This product and - if applicable - the supplied accessories too are marked with "CE" and comply therefore with the applicable harmonized European standards listed under the Directive 2014/30/EU (EMCD), Directive 2014/35/EU (LVD), Directive 2011/65/EU (RoHS), Directive 2014/53/EU. Hereby, Hangzhou Microimage Software Co., Ltd. declares that this device

(refer to the label) is in compliance with Directive 2014/53/EU. The full text of the EU declaration of conformity is available at the following internet address: <https://www.hikmicrotech.com/en/support/download-center/declaration-of-conformity/>

Frequency Bands and Power (for CE)

The frequency bands and transmitting power (radiated and/or conducted) nominal limits applicable to the following radio equipment are as follows:

Wi-Fi 2.4 GHz (2.4 GHz to 2.4835 GHz), 20 dBm

Use the power adapter provided by a qualified manufacturer. Refer to the product specification for detailed power requirements.

Use the battery provided by a qualified manufacturer. Refer to the product specification for detailed battery requirements.



Directive 2012/19/EU (WEEE Directive): Products marked with this symbol cannot be disposed of as unsorted municipal waste in the European Union. For proper recycling, return this product to your local supplier upon the purchase of equivalent new equipment, or dispose of it at designated collection points. For more information see: www.recyclethis.info



Directive 2006/66/EC and its amendment 2013/56/EU (Battery Directive): This product contains a battery that cannot be disposed of as unsorted municipal waste in the European Union. See the product documentation for specific battery information. The battery is marked with this symbol, which may include lettering to indicate cadmium (Cd), lead (Pb), or mercury (Hg). For proper recycling, return the battery to your supplier or to a designated collection point. For more information see: www.recyclethis.info

Industry Canada ICES-003 Compliance

This device meets the CAN ICES-003 (B)/NMB-003(B) standards requirements.

This device complies with Industry Canada license-exempt RSS standard(s). Operation is subject to the following two conditions:

- (1) this device may not cause interference, and
- (2) this device must accept any interference, including interference that may cause undesired operation of the device.

This equipment complies with IC RSS-102 radiation exposure limits set forth for an uncontrolled environment.

Conformité Industrie Canada ICES-003

Cet appareil répond aux exigences des normes CAN ICES-003 (B)/NMB-003 (B).

Cet appareil est conforme aux normes RSS exemptes de licence d'Industrie Canada. Son

fonctionnement est soumis aux deux conditions suivantes :

- (1) cet appareil ne doit pas causer d'interférences, et
- (2) cet appareil doit accepter toute interférence reçue, notamment les interférences susceptibles d'occasionner un fonctionnement indésirable de l'appareil.

Cet appareil est conforme aux limites d'exposition au rayonnement IC RSS-102 établies pour un environnement non contrôlé.

KC

B급 기기: 이 기기는 가정용(B급) 전자파적합기기로서 주로 가정에서 사용하는 것을 목적으로 하며, 모든 지역에서 사용할 수 있습니다.

INFORMATIONEN FÜR PRIVATE HAUSHALTE

1. Getrennte Erfassung von Altgeräten:

Elektro- und Elektronikgeräte, die zu Abfall geworden sind, werden als Altgeräte bezeichnet. Besitzer von Altgeräten haben diese einer vom unsortierten Siedlungsabfall getrennten Erfassung zuzuführen. Altgeräte gehören insbesondere nicht in den Hausmüll, sondern in spezielle Sammel- und Rückgabesysteme.

2. Batterien und Akkus sowie Lampen:

Besitzer von Altgeräten haben Altbatterien und Altakkumulatoren, die nicht vom Altgerät umschlossen sind, die zerstörungsfrei aus dem Altgerät entnommen werden können, im Regelfall vor der Abgabe an einer Erfassungsstelle vom Altgerät zu trennen. Dies gilt nicht, soweit Altgeräte einer Vorbereitung zur Wiederverwendung unter Beteiligung eines öffentlich-rechtlichen Entsorgungsträgers zugeführt werden.

3. Möglichkeiten der Rückgabe von Altgeräten:

Besitzer von Altgeräten aus privaten Haushalten können diese bei den Sammelstellen der öffentlich-rechtlichen Entsorgungsträger oder bei den von Herstellern oder Vertreibern im Sinne des ElektroG eingerichteten Rücknahmestellen unentgeltlich abgeben.

Rücknahmepflichtig sind Geschäfte mit einer Verkaufsfläche von mindestens 400 m² für Elektro- und Elektronikgeräte sowie diejenigen Lebensmittelgeschäfte mit einer Gesamtverkaufsfläche von mindestens 800 m², die mehrmals pro Jahr oder dauerhaft Elektro- und Elektronikgeräte anbieten und auf dem Markt bereitstellen. Dies gilt auch bei Vertrieb unter Verwendung von Fernkommunikationsmitteln, wenn die Lager- und Versandflächen für Elektro- und Elektronikgeräte mindestens 400 m² betragen oder die gesamten Lager- und Versandflächen mindestens 800 m² betragen. Vertreter haben die Rücknahme grundsätzlich durch geeignete Rückgabemöglichkeiten in zumutbarer Entfernung zum jeweiligen Endnutzer zu gewährleisten. Die Möglichkeit der unentgeltlichen Rückgabe eines Altgerätes besteht bei rücknahmepflichtigen Vertreibern unter anderem dann, wenn ein neues gleichartiges Gerät, das im Wesentlichen die gleichen Funktionen erfüllt, an einen Endnutzer abgegeben wird.

4. Datenschutz-Hinweis:

Altgeräte enthalten häufig sensible personenbezogene Daten. Dies gilt insbesondere für Geräte der Informations- und Telekommunikationstechnik wie Computer und Smartphones. Bitte beachten Sie in Ihrem eigenen Interesse, dass für die Löschung der Daten auf den zu entsorgenden Altgeräten jeder Endnutzer selbst verantwortlich ist.

5. Bedeutung des Symbols „durchgestrichene Mülltonne“:



Das auf Elektro- und Elektronikgeräten regelmäßig abgebildete Symbol einer durchgestrichenen Mülltonne weist darauf hin, dass das jeweilige Gerät am Ende seiner Lebensdauer getrennt vom unsortierten Siedlungsabfall zu erfassen ist.



HIKMICRO

See the World in a New Way



Facebook: HIKMICRO Outdoor Instagram: hikmicro_outdoor

YouTube: HIKMICRO Outdoor

LinkedIn: HIKMICRO

Web: www.hikmicrotech.com

E-mail: support@hikmicrotech.com

UD35902B