

# ***RANGE TI***

THERMAL IMAGING SCOPE WITH LASER RANGE FINDER

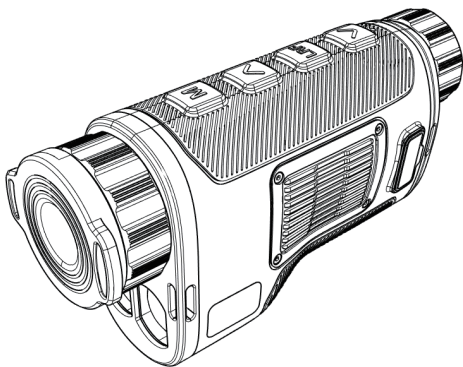
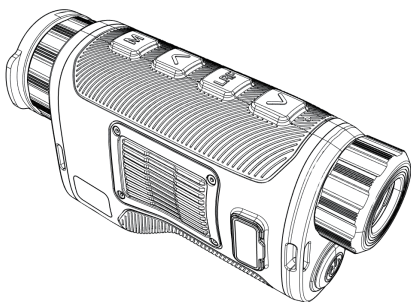

## **Attention!**

Export of **RANGE TI 35 / RANGE TI 50** models  
May have export limitations depending on  
the laws in your region.

RoHS  

## ATTENTION!



The proper usage of the device is important for safe exploitation!  
Therefore read carefully the present manual!



If the device was left in storage for a longer period of time, before exploitation check its functionality.



Disassembling of the device is prohibited, except in authorized repair centers.



The external optical surfaces should be clean at all times. Touching the optical surfaces with bare hands is not recommended.



Sand and sea water can damage the optical coatings!



Do not point the device directly at the sun!



Image performance is dependent on scenery and atmosphere conditions. Contrast in the same image may vary as a function of the time of day due to the effect of the sun. For example, at sunset objects will have absorbed different levels of heat resulting in greater temperature differences and better contrast.



When left in storage for a longer period of time, batteries have to be removed and stored in polyethylene bags to prevent contact with metal. (It is recommended to recharge the batteries every two to three months)



When carrying or transporting the device, put the protective lens cap!



Condensation can cause fogging of the optical surfaces! Condensation occurs when the temperature or humidity changes as follows:

- *When moving the device from cold to warm place or vice versa;*
- *In places with high humidity.*

When equalizing the temperature of the device with the environmental, the condensation disappears. Use the towel to remove moisture.



Clean the lens surfaces with the Lens Cloth or with the napkin!

## LEGAL NOTICE

Before attaching to weapons, check the regional legal regulations in the area of application. The attachment to a weapon is always the sole responsibility of the user.



All images used in this instruction manual are for illustrative purpose only. Actual product may vary due to product enhancement.

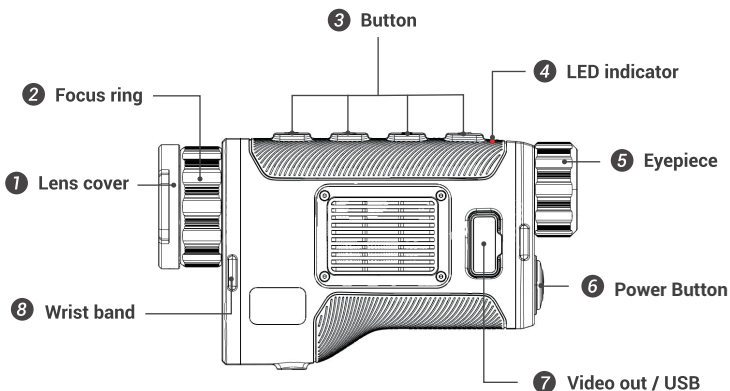

9 Laser rangefinder



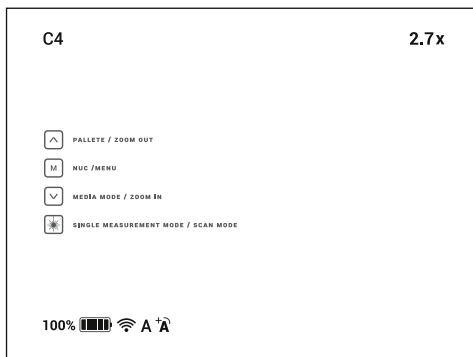

The status display shows information on the actual operating status of the device including:

- **Palette** (C1-C6)
- **Zoom** (50mm:3.9---15.6x 35mm :2.7-10.8x)
- **Help menu**
- **Battery capacity**
- **Wifi**
- **Display modes** (A-C)
- **NUC mode**

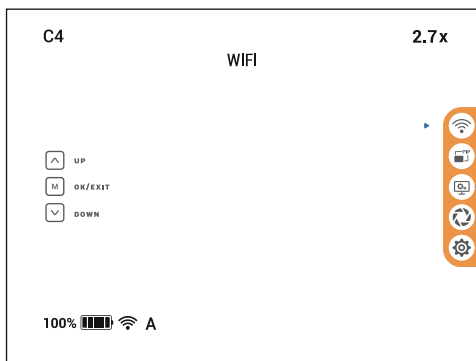

Main menu settings icon

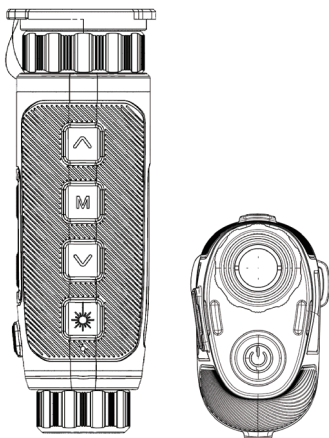

	Quick menu		Main menu	
	Short press	Long press	Short press	Long press
	Palette	Zoom -	Up	/
	NUC	Enter menu / Exit menu / Confirm settings	Enter menu / Exit menu/Save	/
	Media mode	Zoom +	Down	/
	Singe measurement	Scan mode switching	/	/
	Stand-by	Turn on / Turn off	Stand-by	Turn on / Turn off
	/	Adjust Brightness	/	/
	/	Adjust Contrast	/	/



Photo and video recording function are only valid when WIFI is on.

## Start up image

Long press of  button for 3 second to power on device.



## Power off image

Long press of  button for 3 seconds to power off device.

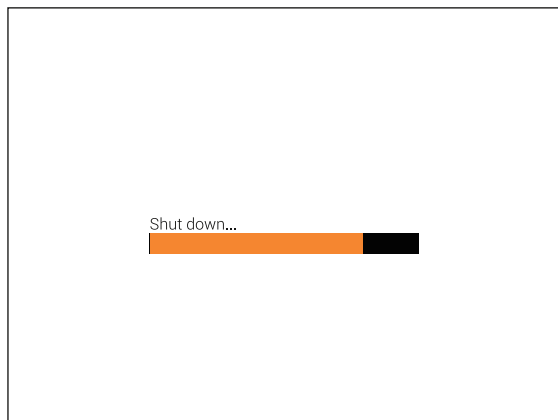

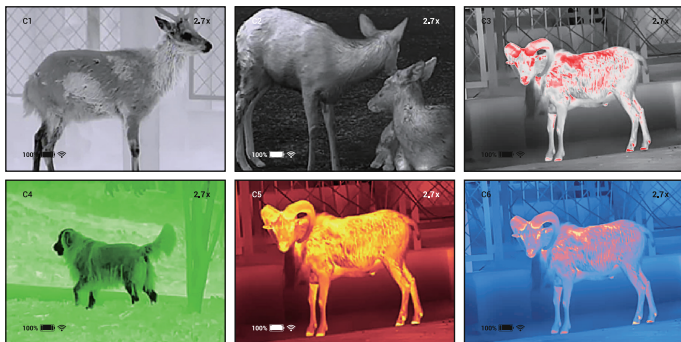

## Palette

Press  button shortly to switch palette from C1-C6.



## Zoom

Long Press  or  to have smooth zoom in and out.

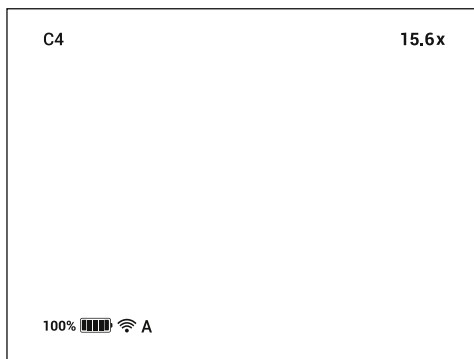

RANGE TI 35 has magnification from 2.7~10.8.

RANGE TI 50 has magnification from 3.9~15.6.

## NUC



Short press  button to act non-uniforming calibration.

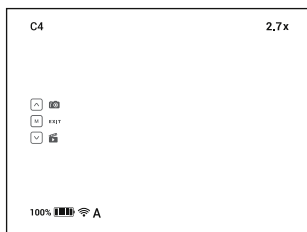

## Take photo / video on board

Short press  button, to have multimedia menu display.



Switch between video and photo by press  and  button.

Short press  button, to start recording video or take a photo, recording icon or number of photo will be shown on upper screen.

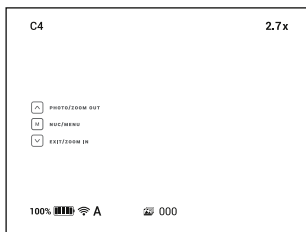
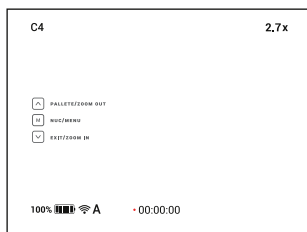

Short press  button to start/end recording.

Long press  button to return to the real-time image.

### Please note the following before using:

- Power on RANGE TI and turn on WIFI, wait for 10s, If customer does not wait for 10 seconds, even he sees the 001 002 to be shown non left upper corner, photos were not really taken and saved, same with videos.
- When you take photos, do not press too quickly, always wait until 001 disappears before you take 002.
- Wait another 10 seconds before you power off the WIFI.
- You cannot take photos/videos while connecting with PC. Otherwise the photos/videos are not actually saved.

# Take photo by Cam802

User can take photo / video on board or by Cam802 App.  
Replay on Smart phone.

To get started, install the free Cam802 App on your mobile device.  
You can search and download at App Store and GooglePlay.



CONOTECH

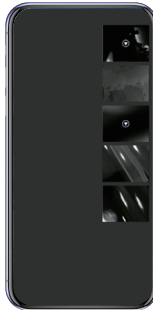
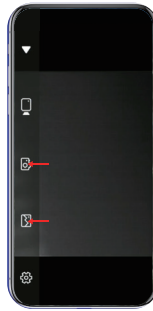
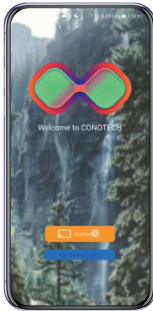
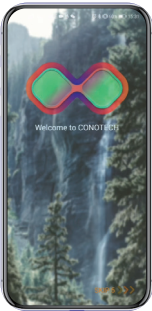

# How to replay on PC ?

- 1.Connect the Micro-usb cable to PC.
- 2.Turn on WIFI and wait 10s.

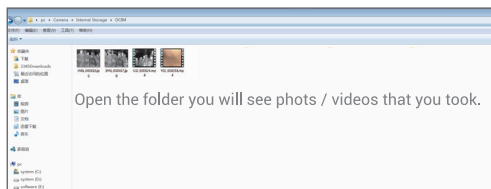
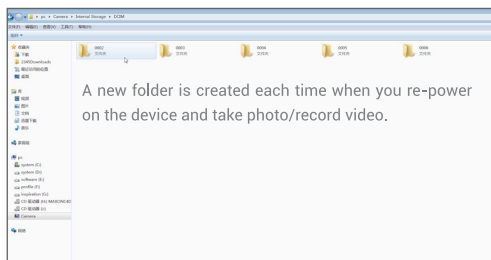
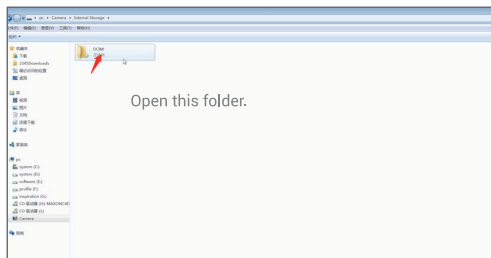
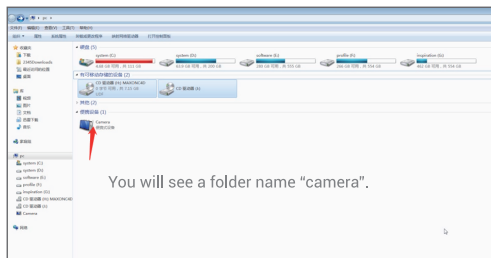

## Laser rangefinder

Short press the  button, the ranging box and distance appear.

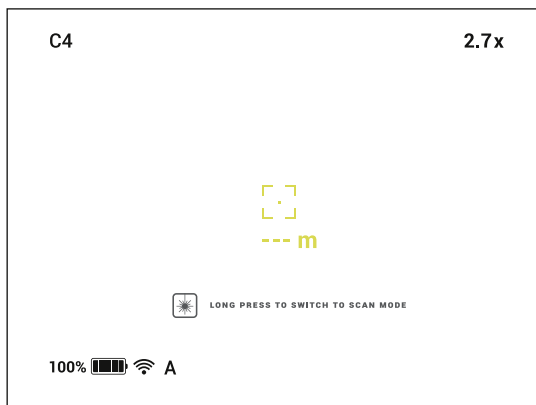

Short press the  button to have range measured once and displayed.

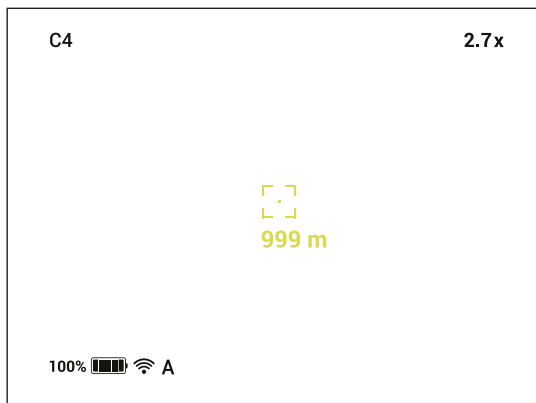

The distance is displayed for 5 seconds then disappear.

Long press  button to start the scan mode, and the scan mode ranging box and distance appear in the real-time image.

Long press  button again to turn off the scan mode. The ranging box and figures will disappear together.

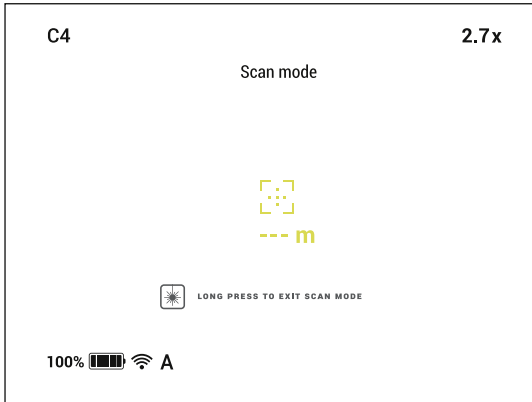

## OPERATING FEATURES:

1. The accuracy and distance of the measurement depends on the reflection coefficient of the object surface and weather conditions. The reflection coefficient depends on the texture, color, size and shape of the object. Generally, lighter colored objects and those with a shiny surface will have a higher reflection coefficient.

2. Measurement accuracy can be influenced by the light conditions, fog, haze, rain, snow, etc. The results may be less accurate when operating in sunny weather or if the rangefinder is directed towards the sun.

3. It is easier and more reliable to measure the distance to large objects than to small ones.

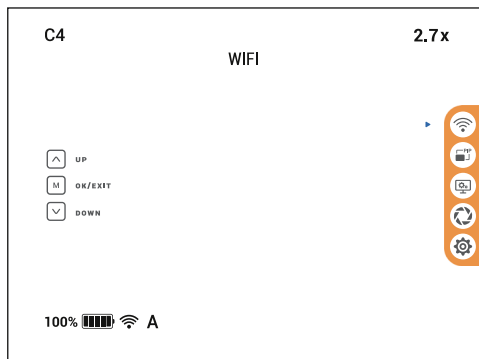

## Wi-Fi

Find Wi-Fi icon from Main menu

Press  or  button to choose then press  button to turn **ON / OFF** Wi-Fi.

Wi-Fi status is shown in the display,  means Wi-Fi is off,  means Wi-Fi is on.

Find WIFI named:  
RANGE TI \*\*\*\*\*

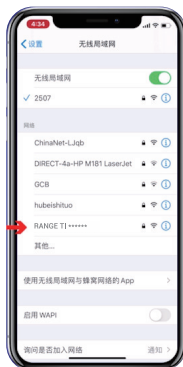



Enter password:  
12345678



After wait for 10s



## PIP Mode

Press the  or  button then press  button to turn PIP Mode **On / Off**.

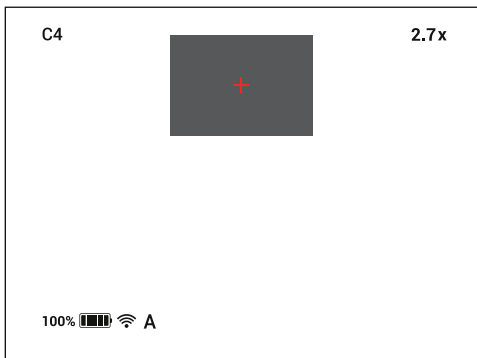



## Observation modes

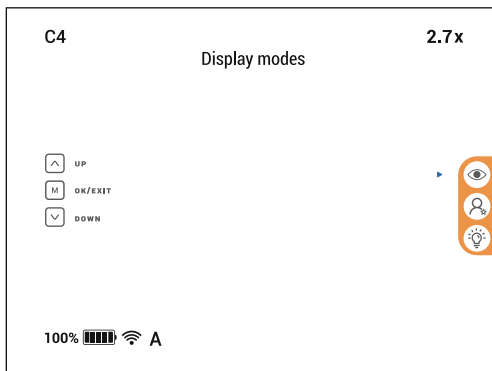

### Display modes:

- A-Normal** The gray difference between the target and the background is large, and the target is prominent.
- B-Enhance** On the basis of normal display, further enhance the details of the image.
- C-Stroke** On the basis of normal display, stroke the target.
- D-Smooth** Suitable for indoor short-distance observation.





## User mode

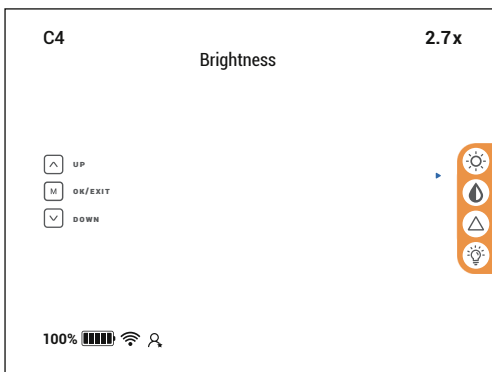

**Brightness** Press the or buttons to change image brightness from 1~5.

You can also enter Brightness adjustment by long press both and buttons in the real image.



**Contrast** Press the or buttons to change display contrast from 1~5.

You can also enter Contrast adjustment by long press both and buttons in the real image.



**Sharpness** Press the or buttons to change sharpness from 1~5.



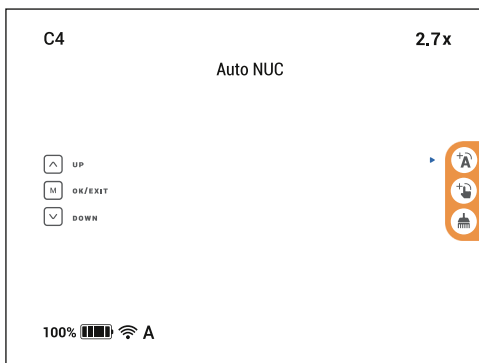

**OLED Brightness** Press the or buttons to change OLED brightness from 1~5.

## Calibration Mode Setting



### Automatic Calibration

Press the  or  button then press  button to turn Automatic Calibration **On / Off**.

In the Automatic Calibration mode, The device is calibrated autonomously according to firmware algorithms.

There is no need to close the lens cover.



### Manual Calibration

Press  buttons, prompt to close the lens cover, and complete after counting down **3-2-1**.



### Defective Pixel Repair

Press  buttons, prompt to close the lens cover, and complete after counting down **3-2-1**.

Defective pixels are found by software algorithm.



## System settings

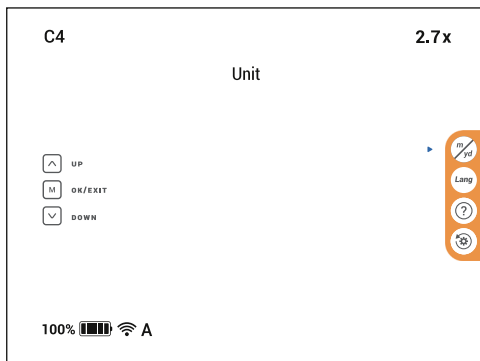

### Unit

Press  or  to select units of measurement from Yards and Meters, then press  button to confirm.



### Language

Press  or  to select language, then press  button to confirm.



### Help

Press the  or  button then press  button to turn help **On / Off**.



### Restore Default Setting

Press  or  buttons to Restore Default Setting. (All parameter settings are restored to default values)

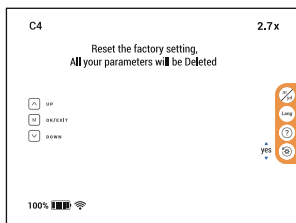

## CHARGING AND FIRMWARE UPDATE

The RANGE TI series comes with built-in rechargeable Lithium-ion battery. Before first use, make sure the battery is fully charged.

Power supply / Firmware update

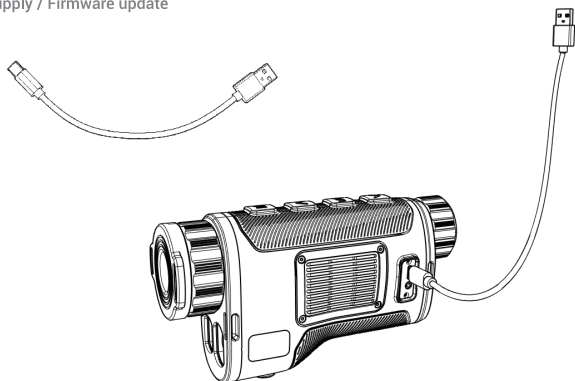

When charging the LED light will be in red color.

When battery is fully charged LED light will be in green color.



### Attention

It is not recommended to use when charging, which will shorten the battery life.

Charging batteries from an external source at temperatures below 0°C can reduce battery life.

When using external power, connect the Power Bank to the device only after it has been turned on and working for at least several minutes.

Video Cable

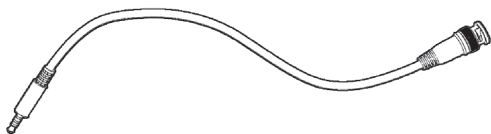

Video cable serves for external displaying

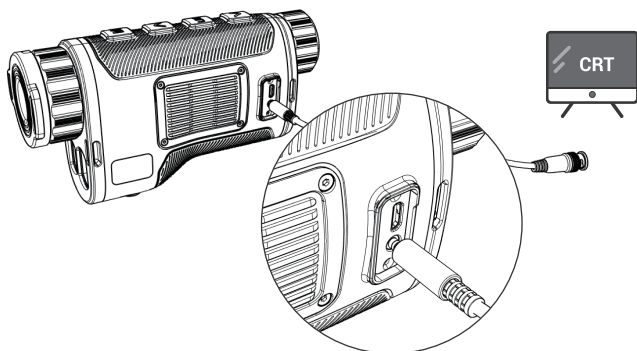

- Before storing it, clean obligatory the device (if on its surface there are moisture, dust or traces of dirt)!
- Make sure that there are no traces of moisture, and the battery compartment is empty!
- It is also possible for a short periods of time device to be stored in a suitable soft pack, bag or cartridge box.
- The premises in which the device is kept for long term have to be dry, enclosed, unheated and ventilated.
- During the storage should not be allowed exposure to aggressive environments, temperatures below  $-50^{\circ}\text{C}$  and above  $+60^{\circ}\text{C}$ , relative humidity greater than 80%, and prolonged periods of direct sunlight.
- Before each transportation, the product should be neatly packed in its original packaging (transport bag) and all other items and accessories should be carefully and steadily placed in the bag. After that the bag should be steadily placed in the transport suitcase.
- You can ship the product with all types of transport at different distances and at altitude up to 12 000 m.

## Technical Data Sheet

Technical Data Sheet		
	RANGE TI 35	RANGE TI 50
<b>Detector</b>		
Type	Uncooled Vox	
Resolution	384×288	
Frame rate	50Hz	
Pitch	17μm	
Spectral range	8-14μm	
NETD	Less than 35mk	
<b>Optical Characteristics</b>		
Objective lens	35mm	50mm
Magnification	2.7x	3.9x
FOV	10.6°×8.0°	7.4°×5.6°
Close-up range	5m	
Dioptre adjustment	-5D-4D	
<b>Functions</b>		
Zoom	Smooth digital zoom	
Palette	6 optional(can be customized)	
Start up time	Less than 5 seconds	
Start up image	Can be customized	
Menu and information	GUI(Can be customized)	
Image enhancement	DDE	
Contrast and brightness	AGC	
Online update	Both code and GUI resources	
<b>Display</b>		
Type	OLED	
Resolution	1024×768	
<b>Power Supply</b>		
Battery	Built-in lithium battery	
External power supply	5V micro USB	
Battery life	8h+	
<b>Physical Characteristics</b>		
Weight without battery	540g	590g
Size	155x50x92mm	165x56x92mm
<b>Environmental Compatibility</b>		
Water proof	IP67	
Operating temperature	-20℃-50℃	
Storage temperature	-40℃-60℃	
<b>Laser Rangefinder</b>		
Safety class for laser equipment according to IEC 60825-1:2014	1	
Measuring range	5-1000m	
Measurement accuracy	±1m	



Hubei CONO Technology Co., Ltd  
Tel/ Fax:0086-27-87137247  
Email: Support@cono-tech.com

[www.cono-tech.com](http://www.cono-tech.com)